

pininfarina
Segno

WRITING & ACCESSORIES



CATALOGO PERSONALIZZATI 2022

CUSTOMIZE CATALOGUE 2022



pininfarina

collection

"Design by Pininfarina"

NEW**SMART**

MATITA

**SCHEDA TECNICA / TECHNICAL SHEET**

| | |
|--|--|
| Materiale corpo <i>Body material</i> | Alluminio anodizzato nero opaco <i>Matt black anodized aluminum</i> |
| Puntale <i>Tip</i> | Compound a base di grafite <i>Graphite Compound</i> |
| Dimensioni corpo <i>Body dimensions</i> | Lunghezza 153mm - Diametro 9mm <i>Lenght 152mm - Diameter 9mm</i> |
| Peso corpo <i>Body weight</i> | 25gr <i>25gr</i> |

Disponibile in 4 varianti
Available in 4 versions



Blu
Blue
NPKRE01785



Verde lime
Lime
NPKRE01786



Rosso
Red
NPKRE01787



Titanio
Titanium
NPKRE01788



Laser engraving (4x4 mm)
UV printing (4x4 mm)



Stampa UV (50x4 mm)
UV printing (50x4 mm)

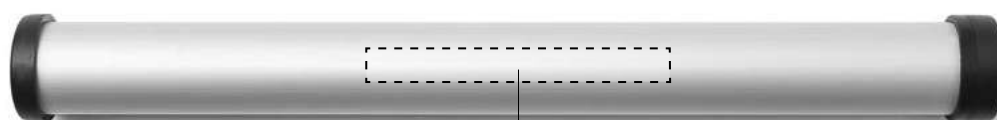

Stampa UV (50x7 mm)
UV printing (50x7 mm)



SCHEDA TECNICA / TECHNICAL SHEET

| | |
|--|--|
| Materiale corpo <i>Body material</i> | Alluminio <i>Aluminium</i> |
| Puntale <i>Tip</i> | Pennino in acciaio (Quattro misure: EF - F - M - B) <i>Stainless steel nib (Four sizes: EF - F - M - B)</i> |
| Ricambio <i>Refill</i> | Schmidt K6 converter <i>Schmidt K6 converter</i> |
| Dimensioni corpo <i>Body dimensions</i> | Lunghezza 150 mm - diametro 20 mm <i>Length 150 mm - diameter 20 mm</i> |
| Peso corpo <i>Body weight</i> | 50gr <i>50gr</i> |



Disponibile in 12 varianti
Available in 12 versions

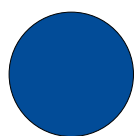

Blue EF **NPKRE01757**
 Blue F **NPKRE01758**
 Blue M **NPKRE01759**
 Blue B **NPKRE01762**

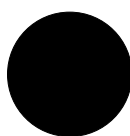

Black EF **NPKRE01772**
 Black F **NPKRE01773**
 Black M **NPKRE01774**
 Black B **NPKRE01775**

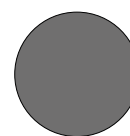

Titanium EF **NPKRE01763**
 Titanium F **NPKRE01764**
 Titanium M **NPKRE01765**
 Titanium B **NPKRE01766**

Luxury Limited Edition

FOUNTAIN



SCHEDA TECNICA / TECHNICAL SHEET

| | |
|--|--|
| Materiale corpo <i>Body material</i> | Alluminio <i>Aluminium</i> |
| Puntale <i>Tip</i> | Pennino d'oro 14Kt. (Due misure: M - F) <i>14 Kt. gold nib (Two sizes: M - F)</i> |
| Ricambio <i>Refill</i> | Schmidt K6 converter <i>Schmidt K6 converter</i> |
| Dimensioni corpo <i>Body dimensions</i> | Lunghezza 150 mm - diametro 20 mm <i>Length 150 mm - diameter 20 mm</i> |
| Peso corpo <i>Body weight</i> | 50gr <i>50gr</i> |



Disponibile in 2 varianti
Available in 2 versions

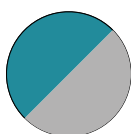

Blue / Silver
Nib M
NPKRE01776

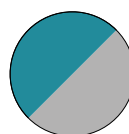

Blue / Silver
Nib F
NPKRE01777

NOVANTA

customize

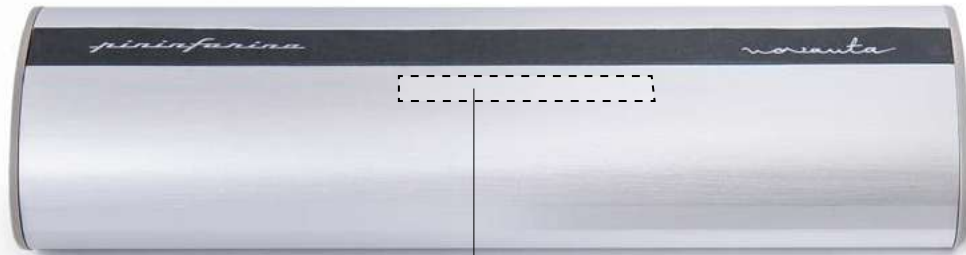

Stampa UV (50x10 mm)
UV printing (50x10 mm)



Incisione laser - stampa UV (35x4 mm)
Laser engraving - UV printing (35x4 mm)





SCHEMA TECNICA / TECHNICAL SHEET

| | |
|--|---|
| Materiale corpo <i>Body material</i> | Alluminio <i>Aluminium</i> |
| Puntale <i>Tip</i> | Punta a sfera <i>Ballpoint ink</i> |
| Ricambio <i>Refill</i> | Parker Style G2 Ballpoint Refill <i>Parker Style G2 Ballpoint Refill</i> |
| Dimensioni corpo <i>Body dimensions</i> | Lunghezza min 140/max 157 mm - diametro min. 11 max 13mm <i>Length min 140mm / max 157mm - diameter min. 11 max 13mm</i> |
| Peso corpo <i>Body weight</i> | 37gr <i>37gr</i> |

Disponibile in 3 varianti
Available in 3 versions



PF ONE Nero
PF ONE Black
NPKRE01695



PF ONE Argento
PF ONE Silver
NPKRE01694



PF ONE Bicolor
PF ONE Bicolor
NPKRE01721

PF ONE

BALLPOINT



Incisione laser - stampa UV 40x4 mm
Laser engraving - UV printing 40x4 mm



Incisione laser - stampa UV 40x4 mm
Laser engraving - UV printing 40x4 mm

Stampa UV 70x25 mm
UV printing 70x25 mm





SCHEDA TECNICA / TECHNICAL SHEET

| | |
|--|---|
| Materiale corpo <i>Body material</i> | Alluminio <i>Aluminium</i> |
| Puntale <i>Tip</i> | Pennino (Quattro misure: EF - F - M - B) <i>Nib (Four sizes: EF - F - M - B)</i> |
| Ricambio <i>Refill</i> | Schmidt K6 converter <i>Schmidt K6 converter</i> |
| Dimensioni corpo <i>Body dimensions</i> | Lunghezza 142 mm - diametro 12 mm <i>Length 142 mm - diameter 12 mm</i> |
| Peso corpo <i>Body weight</i> | 33gr <i>33gr</i> |



Disponibile in 12 varianti
Available in 12 versions



Black EF **NPKRE01709**
 Black F **NPKRE01710**
 Black M **NPKRE01711**
 Black B **NPKRE01712**



Silver EF **NPKRE01713**
 Silver F **NPKRE01714**
 Silver M **NPKRE01715**
 Silver B **NPKRE01716**



Blue/Silver EF **NPKRE01717**
 Blue/Silver F **NPKRE01718**
 Blue/Silver M **NPKRE01719**
 Blue/Silver B **NPKRE01720**

PF ONE

FOUNTAIN



Stampa UV 70x25 mm
UV printing 70x25 mm



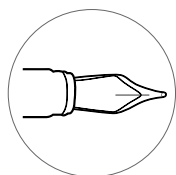

Pennino
Nib



SCHEDA TECNICA / TECHNICAL SHEET

| | |
|--|---|
| Materiale corpo <i>Body material</i> | Alluminio <i>Aluminium</i> |
| Puntale <i>Tip</i> | Pennino (Quattro misure: EF - F - M - B) <i>Nib (Four sizes: EF - F - M - B)</i> |
| Ricambio <i>Refill</i> | Schmidt K6 converter <i>Schmidt K6 converter</i> |
| Dimensioni corpo <i>Body dimensions</i> | Lunghezza 150 mm - diametro 13 mm <i>Length 150 mm - diameter 13 mm</i> |
| Peso corpo <i>Body weight</i> | 45gr <i>45gr</i> |



reddot winner 2021



Disponibile in 8 varianti
Available in 8 versions



- Black EF **NPKRE01728**
- Black F **NPKRE01729**
- Black M **NPKRE01730**
- Black B **NPKRE01731**



- Light Blue EF **NPKRE01732**
- Light Blue F **NPKRE01733**
- Light Blue M **NPKRE01734**
- Light Blue B **NPKRE01735**

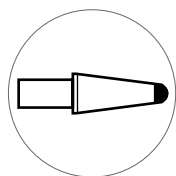

Punta a sfera
Ball point



SCHEDA TECNICA / TECHNICAL SHEET

| | |
|--|--|
| Materiale corpo <i>Body material</i> | Alluminio <i>Aluminium</i> |
| Puntale <i>Tip</i> | Punta a sfera <i>Ballpoint Ink</i> |
| Ricambio <i>Refill</i> | Schmidt P900M <i>SchmidtP900M</i> |
| Dimensioni corpo <i>Body dimensions</i> | Lunghezza 143 mm - diametro 11 mm <i>Length 143 mm - diameter 11 mm</i> |
| Peso corpo <i>Body weight</i> | 47gr <i>47gr</i> |



Disponibile in 2 varianti
Available in 2 versions



PF TWO Nero
PF TWO Black
NPKRE01739



PF TWO Azzurro
PF TWO Light Blue
NPKRE01738

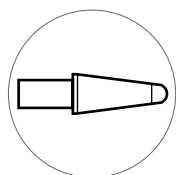

Roller
Roller



SCHEDA TECNICA / TECHNICAL SHEET

| | |
|--|--|
| Materiale corpo <i>Body material</i> | Alluminio <i>Aluminium</i> |
| Puntale <i>Tip</i> | Roller <i>Roller</i> |
| Ricambio <i>Refill</i> | Schmidt SRC5888 <i>Schmidt SRC5888</i> |
| Dimensioni corpo <i>Body dimensions</i> | Lunghezza 150 mm - diametro 13 mm <i>Length 150 mm - diameter 13 mm</i> |
| Peso corpo <i>Body weight</i> | 40gr <i>40gr</i> |



Disponibile in 2 varianti
Available in 2 versions



PF TWO Nero
PF TWO Black
NPKRE01737



PF TWO Azzurro
PF TWO Light Blue
NPKRE01736

PF TWO

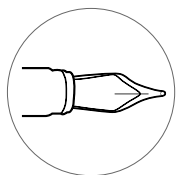

Pennino
Nib

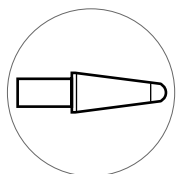

Roller
Roller

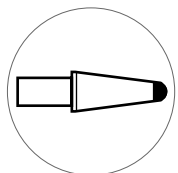

Punta a sfera
Ball point

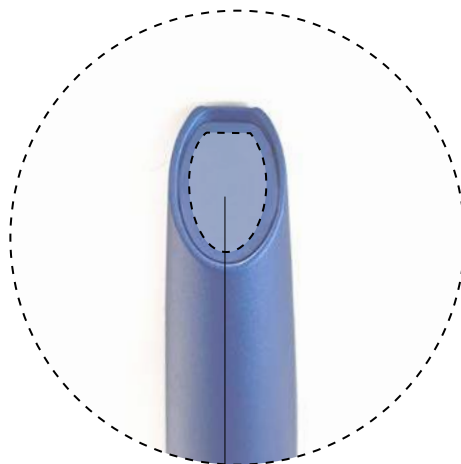

Incisione laser - Laser engraving 4x6 mm



Incisione laser - Laser engraving 5x40 mm

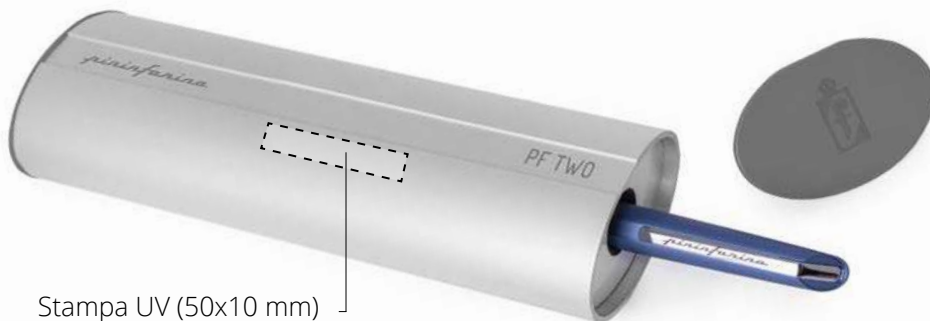

Stampa UV (50x10 mm)
UV printing (50x10 mm)

140 x 210 mm

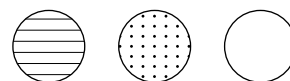
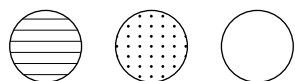
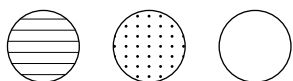
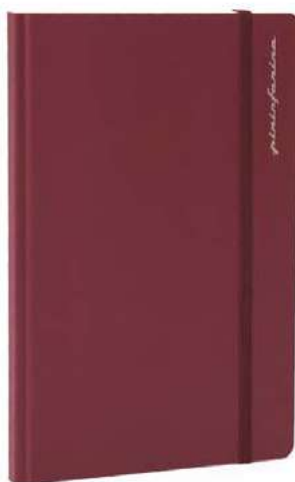

- carta realizzata con scarti di pietre / *paper made from stone waste*
- senza abbattere alberi / *without the felling of trees*
- senza prodotti chimici aggressivi / *without aggressive chemicals*
- senza utilizzare acqua / *without use of water*
- idrorepellente e resistente agli strappi / *waterproof and tear-resistant*
- ridotta emissione di CO2 / *reduced CO2 emissions*

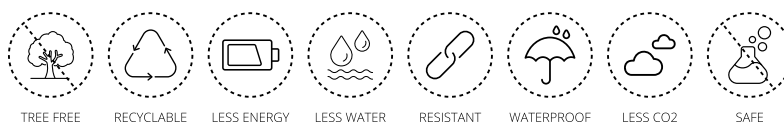

STONE  PAPER

Disponibile in 9 varianti
Available in 9 versions

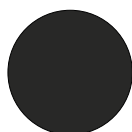

Ruled Black - **PNF1421RUBK**
Dotted Black - **PNF1421DOBK**
Plain Black - **PNF1421PLBK**

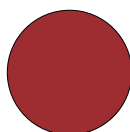

Ruled Red - **PNF1421RURE**
Dotted Red - **PNF1421DORE**
Plain Red - **PNF1421PLRE**

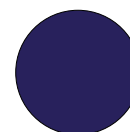

Ruled Blue - **PNF1421RUBL**
Dotted Blue - **PNF1421DOBL**
Plain Blue - **PNF1421PLBL**

NOTEBOOK

140 x 210 mm

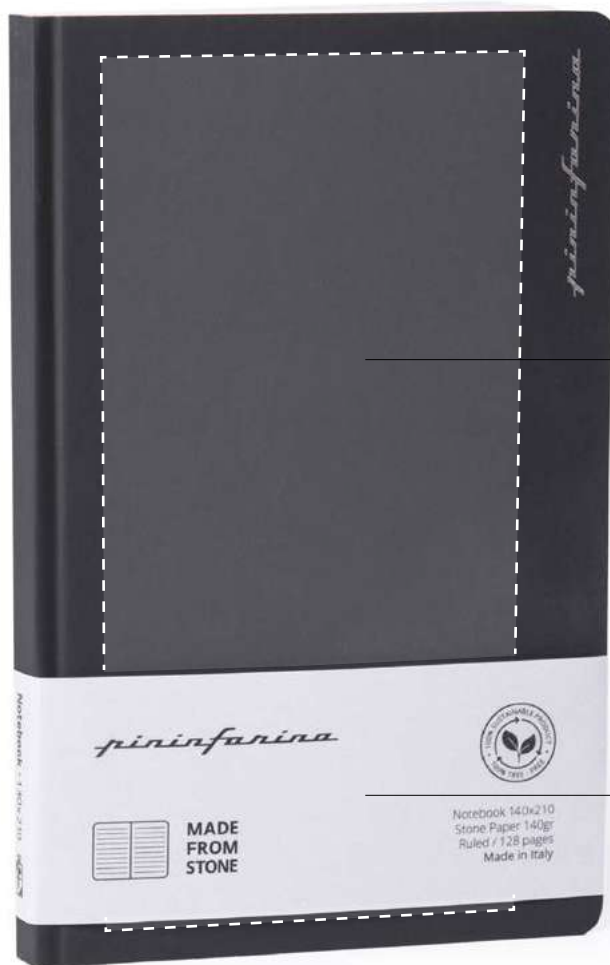

Stampa UV (95x180 mm)
UV Printing (95x180 mm)

Fascetta personalizzabile (130x50 mm)
Customizable paper band (130x50 mm)

- carta realizzata con scarti di pietre / *paper made from stone waste*
- senza abbattere alberi / *without the felling of trees*
- senza prodotti chimici aggressivi / *without aggressive chemicals*
- senza utilizzare acqua / *without use of water*
- idrorepellente e resistente agli strappi / *waterproof and tear-resistant*
- ridotta emissione di CO2 / *reduced CO2 emissions*



TREE FREE



RECYCLABLE



LESS ENERGY



LESS WATER



RESISTANT



WATERPROOF



LESS CO2



SAFE



SCHEDA TECNICA / TECHNICAL SHEET

| | |
|--|---|
| Materiale corpo <i>Body material</i> | Magnesio pressofuso, alette in acciaio <i>Diecast Magnesium with steel clips</i> |
| Puntale <i>Tip</i> | Lega di metalli Ethergraf® <i>Ethergraf® metal alloy</i> |
| Dimensioni stelo <i>Stylus dimensions</i> | Lunghezza 157 mm – H 10 mm <i>Lenght 157 mm – height 10 mm</i> |
| Peso corpo <i>Body weight</i> | 15gr <i>15gr</i> |

Disponibile in 2 varianti
Available in 2 versions

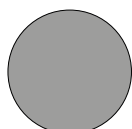

Grigio puro
Pure grey
NPKRE01654



X - Black
Total black
NPKRE01679

SPACE





reddot award 2017
winner

SCHEDA TECNICA / TECHNICAL SHEET

| | |
|--|--|
| Materiale corpo <i>Body material</i> | Alluminio Aerospaziale <i>Aerospace Aluminium body</i> |
| Puntale <i>Tip</i> | Lega di metalli Ethergraf® <i>Ethergraf® metal alloy</i> |
| Dimensioni stelo <i>Stylus dimensions</i> | Lunghezza 160mm - diametro 10mm <i>Lenght 160mm - diameter 10mm</i> |
| Peso corpo <i>Body weight</i> | 17gr <i>17gr</i> |



Disponibile in 2 varianti
Available in 2 versions



Blu
Blue

NPKRE01578



Rosso
Red

NPKRE01588

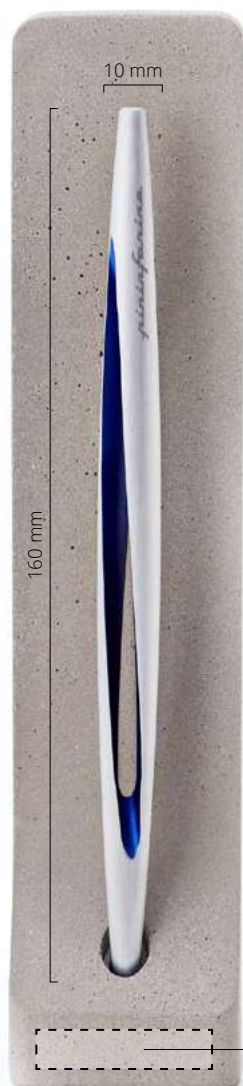

SCHEDA TECNICA / TECHNICAL SHEET

| | |
|---|--|
| Materiale corpo <i>Body material</i> | Alluminio Aerospaziale <i>Aerospace Aluminium body</i> |
| Puntale <i>Tip</i> | Lega di metalli Ethergraf® <i>Ethergraf® metal alloy</i> |
| Dimensioni stelo <i>Stylus dimensions</i> | Lunghezza 160mm - diametro 10mm <i>Length 160mm - diameter 10mm</i> |
| Peso corpo <i>Body weight</i> | 17gr <i>17gr</i> |

Incisione laser (30x13 mm)
Laser engraving (30x13 mm)



Incisione laser (25x20 mm)
Laser engraving (25x20 mm)

Incisione laser (60x7 mm)
Laser engraving (60x7 mm)



INK VERSION
Ink ballpoint stylus

Astuccio
Case

Noce
Walnut

Noce (edizione Gold)
Walnut (Gold edition)

Corpo
Body



Blu notte
Blue
NPKRE01593



Rosso ribes
Red
NPKRE01594



Cromo lucido
Polished chrome
NPKRE01664



Oro rosa
Pink gold
NPKRE01670

ETHERGRAF®
Patented metal alloy tip stylus

Astuccio
Case

Noce
Walnut

Cedro
Cedar

Noce (edizione Gold)
Walnut (Gold edition)

Corpo
Body



Alluminio
Aluminum
NPKRE01511



Nero opaco
Opaque black
NPKRE01515



Nero lucido
Polished black
NPKRE01512



Alluminio
Aluminum
NPKRE01534



Oro pallido
Pale gold
NPKRE01581



Oro rosa
Pink gold
NPKRE01579

CAMBIANO



SCHEDA TECNICA / TECHNICAL SHEET

| | |
|---|---|
| Materiale corpo <i>Body material</i> | Scocca in alluminio e inserti in noce massello <i>Aluminium body with solid walnut inserts</i> |
| Puntale <i>Tip</i> | Lega di metalli Ethergraf® <i>Ethergraf® metal alloy</i> |
| Dimensioni corpo <i>Body dimensions</i> | Lunghezza 160mm - diametro 10mm <i>Length 160mm - diameter 10mm</i> |
| Peso corpo <i>Body weight</i> | 39g <i>39gr</i> |

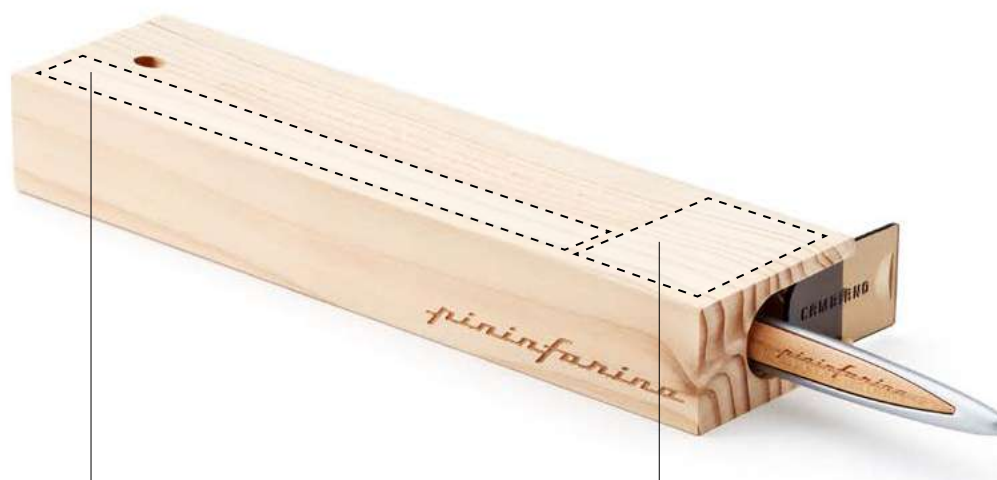

Incisione laser su astuccio in legno (superiore 15x150 / 30x40 mm)
Laser engraving on wooden case (top 15x60 / 30x40 mm)



Special Editions



SCHEDA TECNICA / TECHNICAL SHEET

| | |
|---|--|
| Materiale corpo <i>Body material</i> | Scocca in alluminio e inserti in legno di abete musicale <i>Aluminium body with fir inserts</i> |
| Puntale <i>Tip</i> | Lega di metalli Ethergraf® <i>Ethergraf® metal alloy</i> |
| Dimensioni corpo <i>Body dimensions</i> | Lunghezza 160mm - diametro 10mm <i>Length 160mm - diameter 10mm</i> |
| Peso corpo <i>Body weight</i> | 39gr <i>39gr</i> |

Astuccio
Case

Abete
Fir

Corpo
Body



Legno di abete
Fir wood
NPKRE01708

CAMBIANO

ESSENTIA

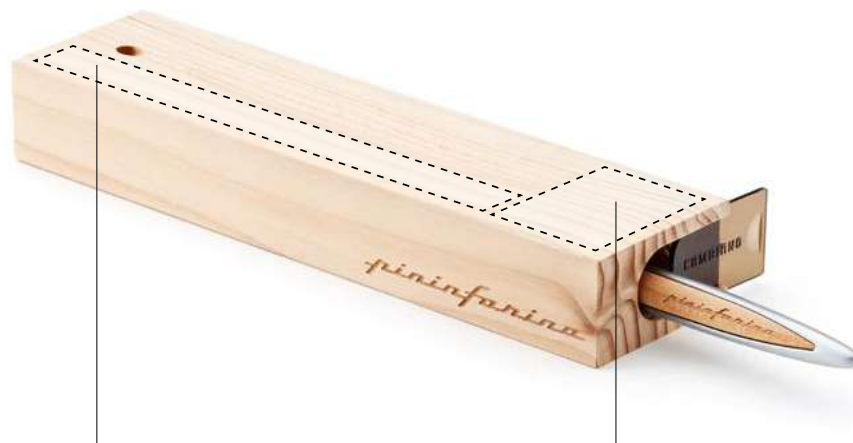
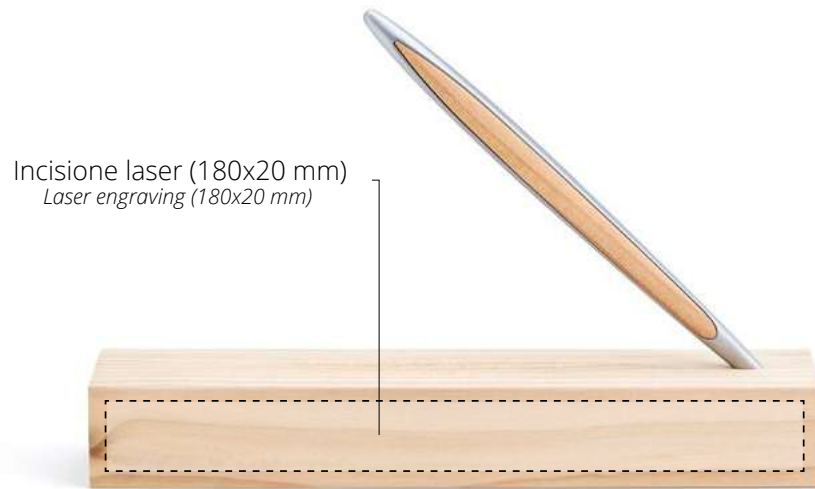

MOON LANDING EDITION
50th anniversary



SCHEDA TECNICA / TECHNICAL SHEET

| | |
|--|--|
| Materiale corpo <i>Body material</i> | Magnesio pressofuso rivestito da film ceramico bianco <i>Diecast magnesium coated with a white ceramic film</i> |
| Materiale basamento <i>Basement material</i> | Basamento circolare in pietra luce <i>Circular basement in light stone</i> |
| Puntale <i>Tip</i> | Lega di metalli Ethergraf® <i>Ethergraf® metal alloy</i> |
| Dimensioni corpo solo stylus <i>Body dimensions, Stylus only</i> | Lunghezza 157 mm – Diametro min 10 mm / max 12 mm <i>Length 157 mm – Diameter min 10 mm / max 12 mm</i> |
| Peso totale <i>Overall weight</i> | 310gr <i>310gr</i> |

Disponibile in 1 variante
Available in 1 version

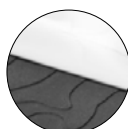

Space Moon Landing Edition
Space Moon Landing Edition
NPKRE01696

SPACE

MOON LANDING EDITION
50th anniversary

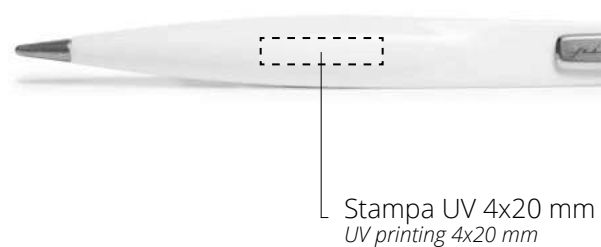
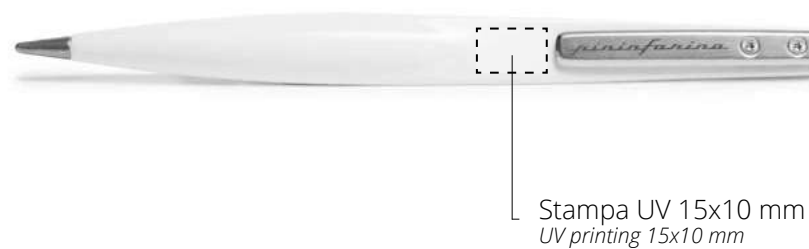
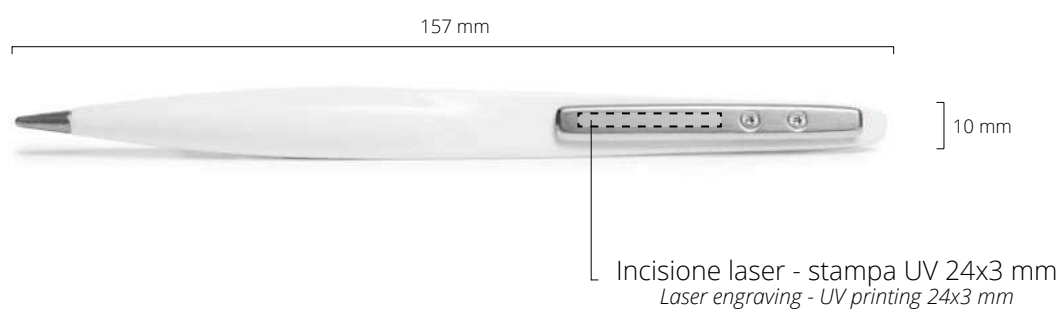



Maserati
EDITION

Eccellenza chiama eccellenza. Un importante passo per il progetto Pininfarina Segno nell'universo del design di livello internazionale, suggellato dalla collaborazione di spicco con Maserati, icona globale delle auto sportive e di lusso. La partnership forte di una visione comune e di valori condivisi, dalla continua ricerca della perfezione all'assoluto equilibrio tra tradizione artigiana e tecniche innovative, ha l'obiettivo di creare una linea esclusiva di prodotti nel mondo writing ed accessories che prende ispirazione dai gioielli a quattro ruote del Tridente.

***A call to Excellence.** Pininfarina Segno takes a meaningful step into the realm of world-class international design, striking an alliance with the iconic luxury sportscar firm Maserati. A partnership whose force resides in the common vision and shared values: from the continuous research for excellence in every detail, to the perfect balance between artisan tradition and innovative techniques. The ambitious goal, is to create the most refined set of writing instruments, inspired by the four-wheel jewels of the iconic Trident.*



NEW

Maserati
EDITION

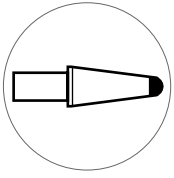
PF TWO**BALLPOINT**

Punta a sfera
Ball point

**SCHEDA TECNICA / TECHNICAL SHEET**

| | |
|--|--|
| Materiale corpo <i>Body material</i> | Alluminio <i>Aluminium</i> |
| Puntale <i>Tip</i> | Punta a sfera <i>Ballpoint Ink</i> |
| Ricambio <i>Refill</i> | Schmidt P900M <i>SchmidtP900M</i> |
| Dimensioni corpo <i>Body dimensions</i> | Lunghezza 143 mm - diametro 11 mm <i>Length 143 mm - diameter 11 mm</i> |
| Peso corpo <i>Body weight</i> | 47gr <i>47gr</i> |



Disponibile in 1 variante
Available in 1 version



PF TWO Nero M
PF TWO Black M
920030136



SCHEDA TECNICA / TECHNICAL SHEET

| | |
|--|--|
| Materiale corpo <i>Body material</i> | Alluminio <i>Aluminium</i> |
| Puntale <i>Tip</i> | Pennino (Due misure: F - M) <i>Nib (Two sizes: F - M)</i> |
| Ricambio <i>Refill</i> | Schmidt K6 converter <i>Schmidt K6 converter</i> |
| Dimensioni corpo <i>Body dimensions</i> | Lunghezza 142 mm - diametro 12 mm <i>Length 142 mm - diameter 12 mm</i> |
| Peso corpo <i>Body weight</i> | 33gr <i>33gr</i> |



Disponibile in 2 varianti
Available in 2 versions



PF ONE Blu Scuro / Pennino F
PF ONE Dark Blue / Nib F
PNFPFONEMASF



PF ONE Blu Scuro / Pennino M
PF ONE Dark Blue / Nib M
PNFPFONEMAS



SCHEDA TECNICA / TECHNICAL SHEET

| | |
|--|---|
| Materiale corpo <i>Body material</i> | Scocca in alluminio e inserti in legno di cedro <i>Aluminium body with cedar inserts</i> |
| Puntale <i>Tip</i> | Lega di metalli Ethergraf® <i>Ethergraf® metal alloy</i> |
| Dimensioni corpo <i>Body dimensions</i> | Lunghezza 160mm - diametro 10mm <i>Length 160mm - diameter 10mm</i> |
| Peso corpo <i>Body weight</i> | 39gr <i>39gr</i> |

Astuccio
Case

Cedro
Cedar

Corpo
Body



Alluminio
Aluminum
PNFCMBMAS1



SCHEDA TECNICA / TECHNICAL SHEET

| | |
|--|--|
| Materiale corpo <i>Body material</i> | Alluminio Aerospaziale <i>Aerospace Aluminium body</i> |
| Puntale <i>Tip</i> | Lega di metalli Ethergraf® <i>Ethergraf® metal alloy</i> |
| Materiale basamento <i>Basement material</i> | Basamento in pietra luce <i>Basement in light stone</i> |
| Dimensioni stelo <i>Stylus dimensions</i> | Lunghezza 160mm - diametro 10mm <i>Lenght 160mm - diameter 10mm</i> |
| Peso corpo <i>Body weight</i> | 17gr <i>17gr</i> |

Disponibile in 1 variante
Available in 1 version

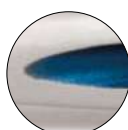

Blu
Blue

PNFAEROMAS

140 x 210 mm



- carta realizzata con scarti di pietre / *paper made from stone waste*
- senza abbattere alberi / *without the felling of trees*
- senza prodotti chimici aggressivi / *without aggressive chemicals*
- senza utilizzare acqua / *without use of water*
- idrorepellente e resistente agli strappi / *waterproof and tear-resistant*
- ridotta emissione di CO2 / *reduced CO2 emissions*

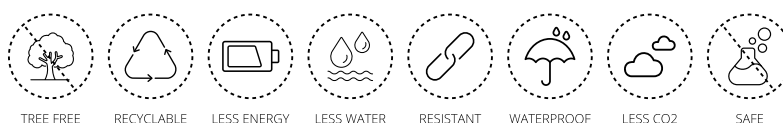

TREE FREE

RECYCLABLE

LESS ENERGY

LESS WATER

RESISTANT

WATERPROOF

LESS CO2

SAFE

STONE  PAPER

Disponibile in 1 variante
Available in 1 version

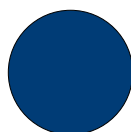

Blu / Righe
Blue / Ruled
PNF1421MASE



SCHEDA TECNICA / TECHNICAL SHEET

| | |
|---|--|
| Materiale corpo <i>Body material</i> | Stelo in alluminio tornito <i>Turned aluminium</i> |
| Puntale <i>Tip</i> | Lega di metalli Ethergraf® <i>Ethergraf® metal alloy</i> |
| Dimensioni corpo <i>Body dimensions</i> | Lunghezza 113mm - diametro 10mm <i>Length 113mm - diameter 10mm</i> |
| Peso corpo <i>Body weight</i> | 17gr <i>17gr</i> |

Disponibile in 3 variante
Available in 3 version

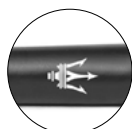

Primina Nero
Primina Black
FORPRMMASS



Primina Bianco
Primina White
FORPRMMASN



Primina Blu
Primina Blue
FORPRMMASB

customize

PF TWO Ballpoint



Incisione laser - stampa UV 30x4 mm
Laser engraving - UV printing 30x4 mm



Stampa UV (50x10 mm)
UV printing (50x10 mm)

PF ONE Fountain



Incisione laser - stampa UV 40x4 mm
Laser engraving - UV printing 40x4 mm

CAMBIANO

Incisione laser (180x20 mm)
Laser engraving (180x20 mm)

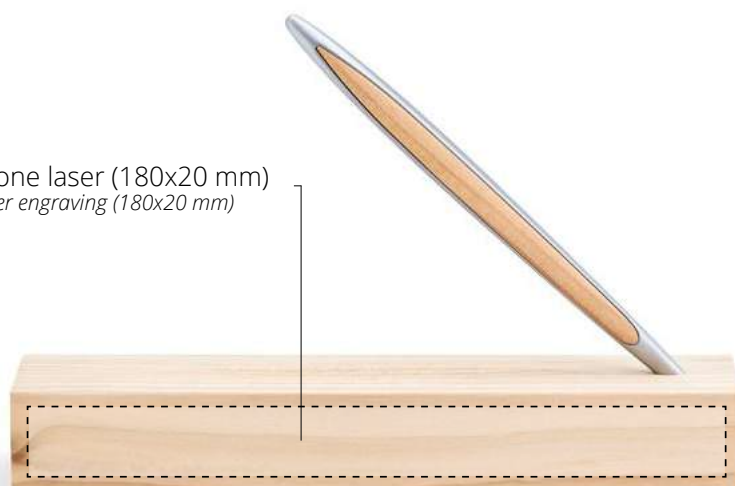

customize

AERO



Incisione laser (25x20 mm)
Laser engraving (25x20 mm)

Incisione laser (60x7 mm)
Laser engraving (60x7 mm)

NOTEBOOK

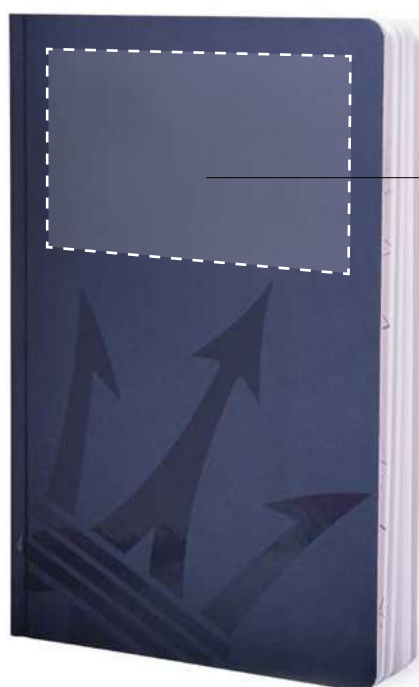

Stampa UV (120x90 mm)
UV Printing (120x90 mm)

PRIMINA



Stampa UV (max 30x5 mm)
UV printing (max 30x5 mm)

licity and harmony
re is still something
y of beauty.”

Pinin Farina
(Tokyo, maggio 1960)

Anniversary Editions

700TH ANNIVERSARY

Dante Alighieri

Un'edizione esclusiva celebra i 700 anni dalla scomparsa di un autore della letteratura mondiale dall'ineguagliabile fortuna iconografica. Probabilmente nessuno nella storia è stato ritratto al pari di *Dante Alighieri* i cui attributi lo rendono inconfondibile nonostante le diverse rappresentazioni che la storia ci ha lasciato.

An exclusive edition celebrates the 700th anniversary of the death of one of the biggest author of world literature, with an incomparable iconographic success. Probably no one in history has been portrayed in the same way as Dante Alighieri, whose features make him unmistakable despite the different representations that history has left us.



SCHEDA TECNICA / TECHNICAL SHEET

| | |
|---|---|
| Materiale corpo <i>Body material</i> | Scocca in alluminio e inserti in legno di cedro <i>Aluminium body with cedar inserts</i> |
| Puntale <i>Tip</i> | Lega di metalli Ethergraf® <i>Ethergraf® metal alloy</i> |
| Dimensioni corpo <i>Body dimensions</i> | Lunghezza 160mm - diametro 10mm <i>Length 160mm - diameter 10mm</i> |
| Peso corpo <i>Body weight</i> | 39gr <i>39gr</i> |

Astuccio
Case

Cedro
Cedar

Disponibile in 2 varianti
Available in 2 versions

Corpo
Body



Alluminio
Aluminum

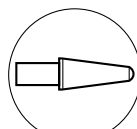

Punta in Ethergraf®
Ethergraf® tip
NPKRE01754

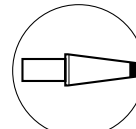

Punta a sfera
Ball point
NPKRE01755



SCHEDA TECNICA / TECHNICAL SHEET

| | |
|---|---|
| Materiale corpo <i>Body material</i> | Scocca in alluminio e inserti in legno di cedro <i>Aluminium body with cedar inserts</i> |
| Puntale <i>Tip</i> | Lega di metalli Ethergraf® <i>Ethergraf® metal alloy</i> |
| Dimensioni corpo <i>Body dimensions</i> | Lunghezza 160mm - diametro 10mm <i>Length 160mm - diameter 10mm</i> |
| Peso corpo <i>Body weight</i> | 39gr <i>39gr</i> |

Astuccio
Case

Cedro
Cedar

Disponibile in 2 varianti
Available in 2 versions

Corpo
Body



Alluminio
Aluminum

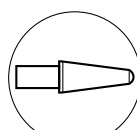

Punta in Ethergraf®
Ethergraf® tip
NPKRE01750

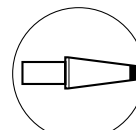

Punta a sfera
Ball point
NPKRE01752



SCHEDA TECNICA / TECHNICAL SHEET

| | |
|---|---|
| Materiale corpo <i>Body material</i> | Scocca in alluminio e inserti in legno di cedro <i>Aluminium body with cedar inserts</i> |
| Puntale <i>Tip</i> | Lega di metalli Ethergraf® <i>Ethergraf® metal alloy</i> |
| Dimensioni corpo <i>Body dimensions</i> | Lunghezza 160mm - diametro 10mm <i>Length 160mm - diameter 10mm</i> |
| Peso corpo <i>Body weight</i> | 39gr <i>39gr</i> |

Astuccio
Case

Cedro
Cedar

Disponibile in 2 varianti
Available in 2 versions

Corpo
Body



Alluminio
Aluminum

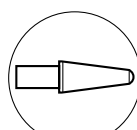

Punta in Ethergraf®
Ethergraf® tip
NPKRE01751

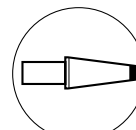

Punta a sfera
Ball point
NPKRE01753



SCHEDA TECNICA / TECHNICAL SHEET

| | |
|--|---|
| Materiale corpo <i>Body material</i> | Stelo in legno di acero naturale bruciato <i>Natural burnt maple wood stem</i> |
| Puntale <i>Tip</i> | Lega di metalli Ethergraf® <i>Ethergraf® metal alloy</i> |
| Dimensioni corpo <i>Body dimensions</i> | Lunghezza 155mm - diametro 10mm <i>Length 155mm - diameter 10mm</i> |
| Peso corpo <i>Body weight</i> | 7gr <i>7gr</i> |

Disponibile in 1 variante
Available in 1 version



Legno di acero naturale bruciato
Natural burnt maple wood
NPKRE01756



SCHEDA TECNICA / TECHNICAL SHEET

| | |
|---|--|
| Materiale corpo <i>Body material</i> | Corpo in legno con anella in argento placcata oro <i>Body in wood, with a silver ring gold plated</i> |
| Puntale <i>Tip</i> | Mina in grafite diam. 2mm <i>Graphite lead (diam. 2mm)</i> |
| Dimensioni corpo <i>Body dimensions</i> | Lunghezza 150mm - diametro 6mm - 11mm <i>Length 150mm - diameter 6mm - 11mm</i> |
| Peso corpo <i>Body weight</i> | 6-8gr <i>6-8gr</i> |

Edizione speciale
Special Edition



Ciliegio fiammato
Flamed cherry
STZ001IN

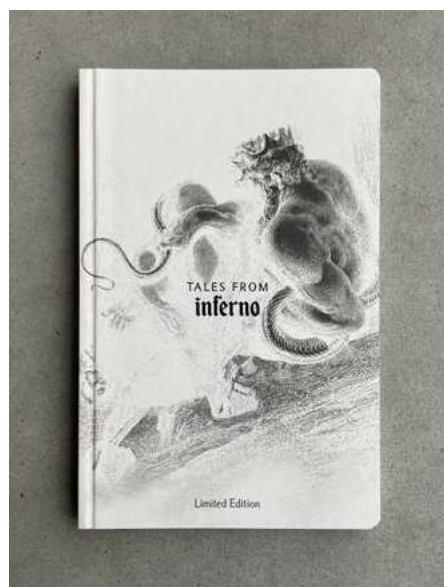

- carta realizzata con scarti di pietre / *paper made from stone waste*
- senza abbattere alberi / *without the felling of trees*
- senza prodotti chimici aggressivi / *without aggressive chemicals*
- senza utilizzare acqua / *without use of water*
- idrorepellente e resistente agli strappi / *waterproof and tear-resistant*
- ridotta emissione di CO2 / *reduced CO2 emissions*



TREE FREE

RECYCLABLE

LESS ENERGY

LESS WATER

RESISTANT

WATERPROOF

LESS CO2

SAFE

STONE  PAPER

Disponibile in 1 variante
Available in 1 version



Notebook Inferno
Notebook Inferno
PNF1421PLIN

customize

CAMBIANO

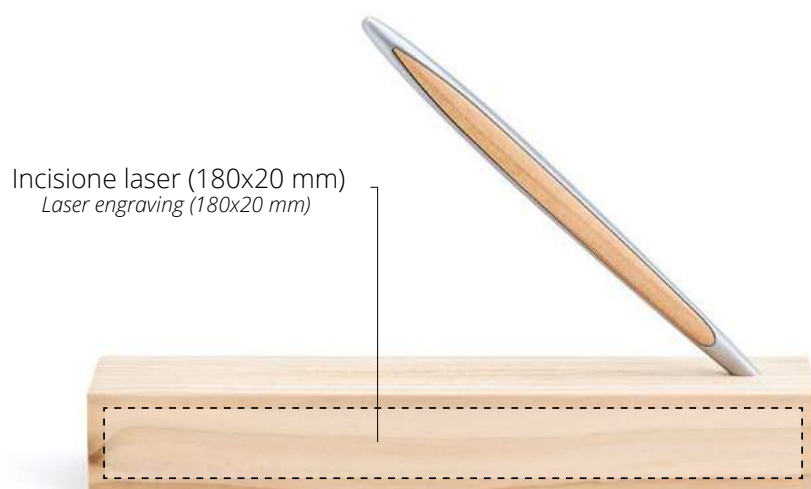

PIUMA



customize

SOSTANZA



Incisione laser (35x0,4 mm)
Laser engraving 35x0,4 mm

NOTEBOOK

Stampa UV (50x40 mm)
UV Printing (50x40 mm)

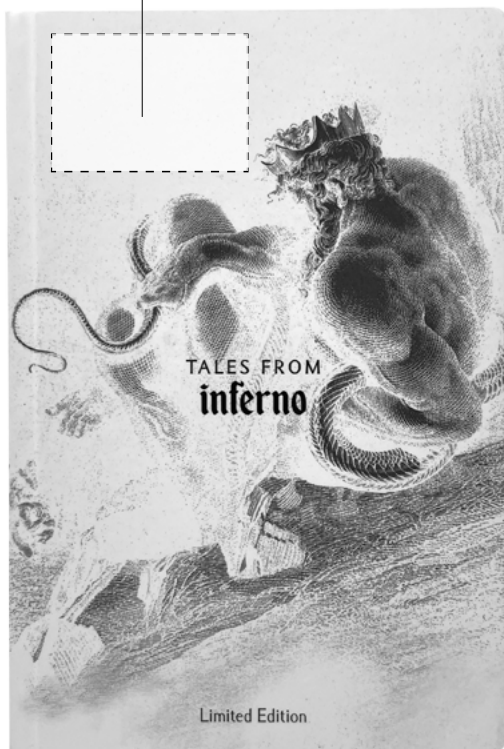

Stampa UV (100x50 mm)
UV Printing (100x50 mm)



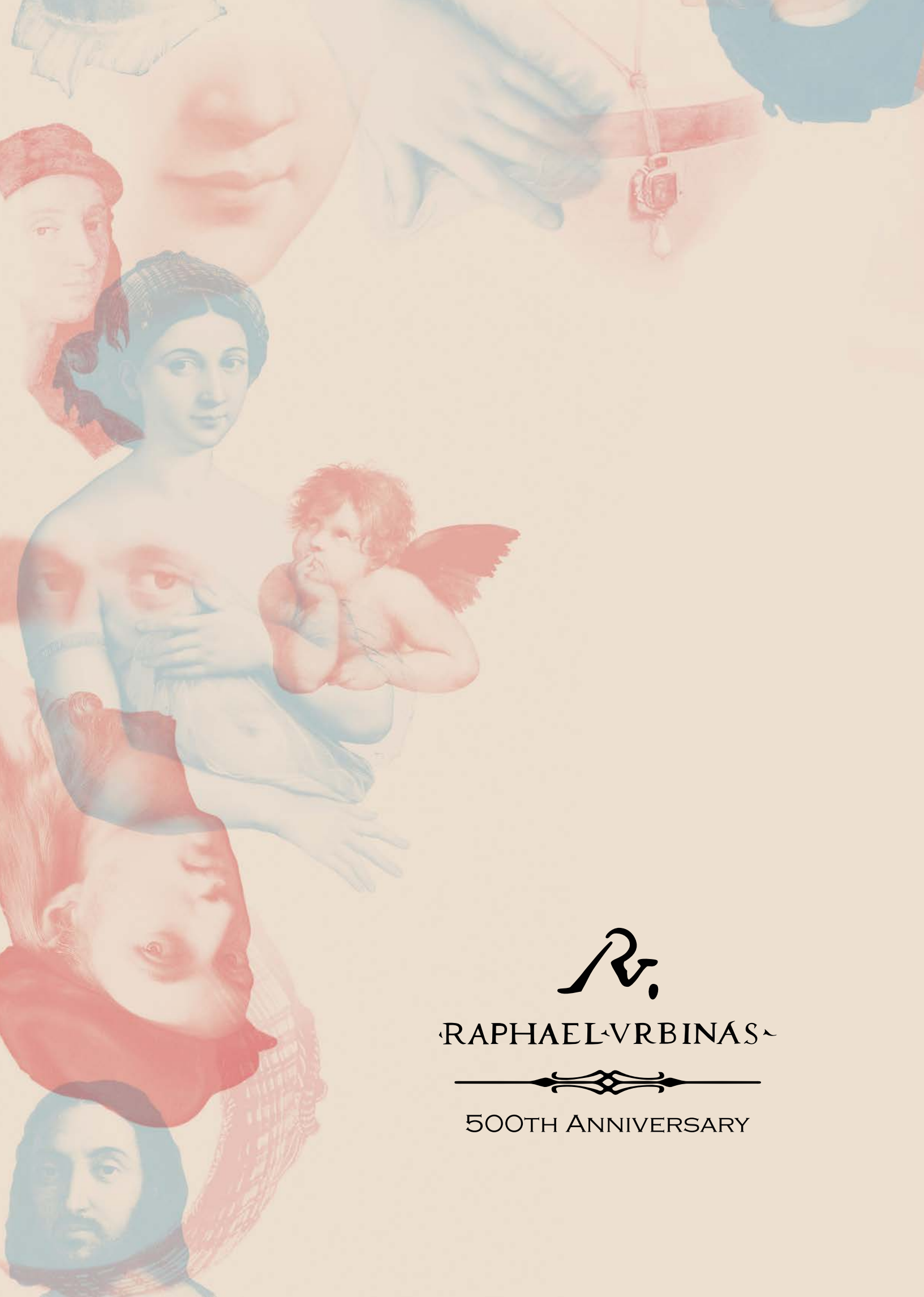

R.

RAPHAEL VRBINAS



500TH ANNIVERSARY



RAPHAEL URBINAS

CAMBIANO

RAPHAEL URBINAS
500TH ANNIVERSARY



SCHEDA TECNICA / TECHNICAL SHEET

| | |
|--|---|
| Materiale corpo <i>Body material</i> | Scocca in alluminio e inserti in legno di cedro <i>Aluminium body with cedar inserts</i> |
| Puntale <i>Tip</i> | Lega di metalli Ethergraf® <i>Ethergraf® metal alloy</i> |
| Dimensioni corpo <i>Body dimensions</i> | Lunghezza 160mm - diametro 10mm <i>Length 160mm - diameter 10mm</i> |
| Peso corpo <i>Body weight</i> | 39gr <i>39gr</i> |

Astuccio
Case

Cedro
Cedar

Corpo
Body



Alluminio
Aluminum
NPKRE01722

R.

RAPHAEL VRBINAS

PIUMA

RAPHAEL VRBINAS
500TH ANNIVERSARY



SCHEDA TECNICA / TECHNICAL SHEET

| | |
|--|--|
| Materiale corpo <i>Body material</i> | Stelo in legno di acero naturale <i>Stem in maple wood</i> |
| Puntale <i>Tip</i> | Lega di metalli Ethergraf® <i>Ethergraf® metal alloy</i> |
| Dimensioni corpo <i>Body dimensions</i> | Lunghezza 155mm - diametro 10mm <i>Length 155mm - diameter 10mm</i> |
| Peso corpo <i>Body weight</i> | 7gr <i>7gr</i> |

Disponibile in 1 variante
Available in 1 version



Legno di acero naturale
Natural maple wood
NPKRE01723

customize

CAMBIANO

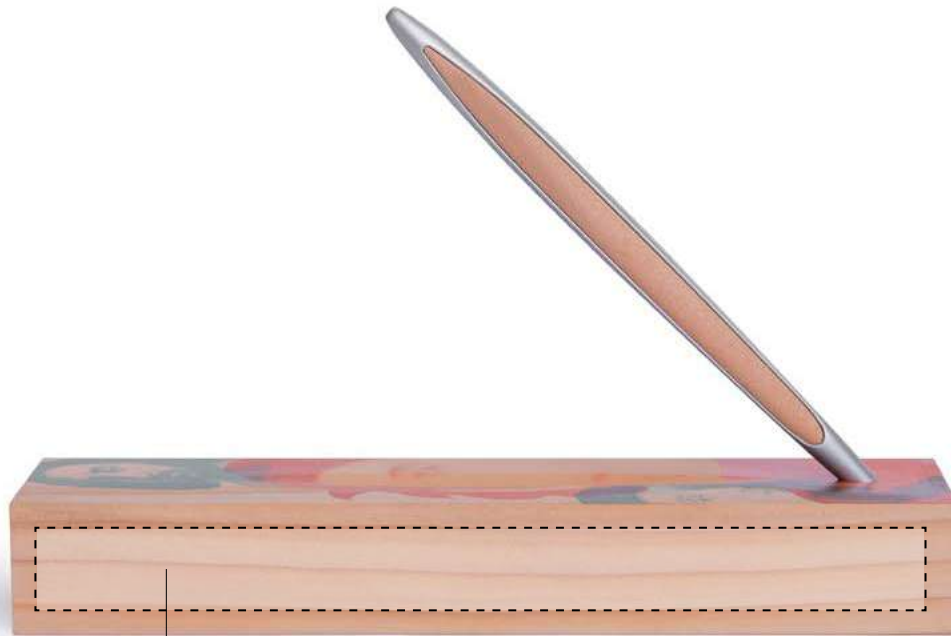

Incisione laser (180x20 mm)
Laser engraving (180x20 mm)

PIUMA



Incisione laser (40x0,4 mm)
Laser engraving (40x0,4 mm)



Handwritten text in a cursive script, likely a manuscript or notebook page, partially visible and slightly blurred. The text is written in a dark ink on a light background, and appears to be a mix of Latin and Italian. The script is dense and fills the lower half of the page, with some lines being more prominent than others. The text is oriented horizontally but appears to be part of a larger document that has been tilted or rotated.



Nel segno di Leonardo

500th ANNIVERSARY

LEONARDO DRAWING / 500TH LIMITED



SCHEDA TECNICA / TECHNICAL SHEET

| | |
|---|---|
| Materiale corpo <i>Body material</i> | Scocca in alluminio e inserti in legno di cedro <i>Aluminium body with cedar inserts</i> |
| Puntale <i>Tip</i> | Punta a sfera / Lega di metalli Ethergraf® <i>Ink ballpoint / Ethergraf® metal alloy</i> |
| Dimensioni corpo <i>Body dimensions</i> | Lunghezza 160mm - diametro 10mm <i>Length 160mm - diameter 10mm</i> |
| Peso corpo <i>Body weight</i> | 39gr <i>39gr</i> |

Astuccio
Case

Cedro
Cedar

Corpo
Body



Alluminio
Aluminium

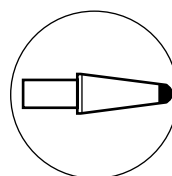

Punta a sfera
Ball point
NPKRE01688

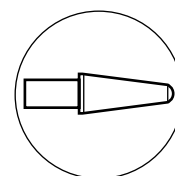

Punta in Ethergraf®
Ethergraf® tip
NPKRE01683



SCHEDA TECNICA / TECHNICAL SHEET

| | |
|--|---|
| Materiale corpo <i>Body material</i> | Stelo in legno di pero evaporato <i>Stem in evaporated pear wood</i> |
| Puntale <i>Tip</i> | Lega di metalli Ethergraf® <i>Ethergraf® metal alloy</i> |
| Dimensioni corpo <i>Body dimensions</i> | Lunghezza 155mm - diametro 10mm <i>Length 155mm - diameter 10mm</i> |
| Peso corpo <i>Body weight</i> | 7gr <i>7gr</i> |

Disponibile in 2 varianti
Available in 2 versions



Legno di acero naturale
Maple wood
NPKRE01691

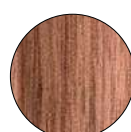

Legno di pero evaporato
Evaporated pear wood
NPKRE01680

Nel segno di Leonardo

PRIMINA LEONARDO

500TH LIMITED

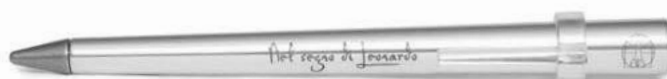

SCHEDA TECNICA / TECHNICAL SHEET

| | |
|---|--|
| Materiale corpo <i>Body material</i> | Stelo in alluminio tornito <i>Turned aluminium</i> |
| Puntale <i>Tip</i> | Lega di metalli Ethergraf® <i>Ethergraf® metal alloy</i> |
| Dimensioni corpo <i>Body dimensions</i> | Lunghezza 113mm - diametro 10mm <i>Length 113mm - diameter 10mm</i> |
| Peso corpo <i>Body weight</i> | 17gr <i>17gr</i> |

Disponibile in 1 variante
Available in 1 version



Primina Leonardo
Primina Leonardo
NPKRE01699

Nel segno di Leonardo

Leonardo 500th Limited

customize

CAMBIANO



Incisione laser (180x20 mm)
Laser engraving (180x20 mm)

PIUMA



Incisione laser (40x0,4 mm)
Laser engraving (40x0,4 mm)

PRIMINA

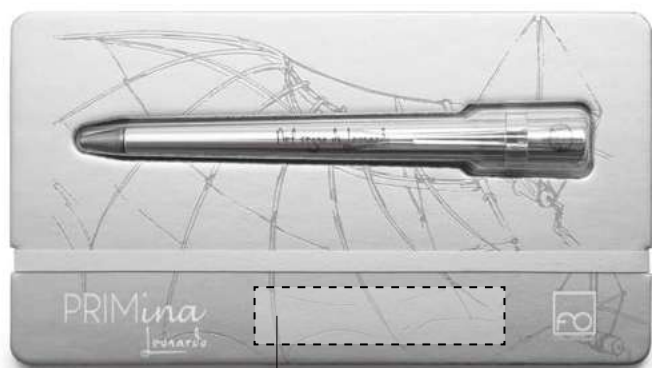

Stampa UV (60x10 mm)
UV Printing (60x10 mm)



Stampa UV (110x30 mm)
UV Printing (110x30 mm)

Brands we like collection

“Prodotti selezionati da Pininfarina Segno per l'eccellenza
nel design e nell'innovazione”



SCHEDA TECNICA / TECHNICAL SHEET

| | |
|--|--|
| Materiale corpo <i>Body material</i> | Alluminio verniciato <i>Painted aluminium</i> |
| Puntale <i>Tip</i> | Compound a base di grafite <i>Graphite Compound</i> |
| Dimensioni corpo <i>Body dimensions</i> | Lunghezza 152mm - Larghezza 12mm <i>Length 152mm - Width 12mm</i> |
| Peso corpo <i>Body weight</i> | 26gr <i>26gr</i> |



Disponibile in 6 varianti
Available in 6 versions



Blu
Blue
GFX001BL

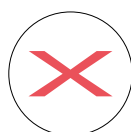

Rosso
Red
GFX001RO

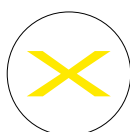

Giallo
Yellow
GFX001GI



Verde
Green
GFX001VE



Arancione
Orange
GFX001AR



Viola
Purple
GFX001VI

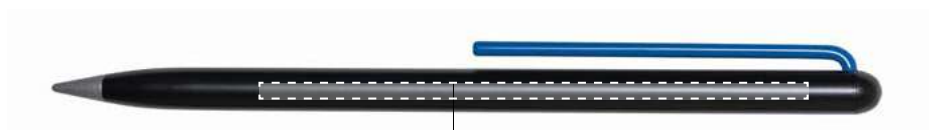

Incisione laser - Stampa UV (max 110x5 mm)
Laser engraving - UV printing (max 110x5 mm)

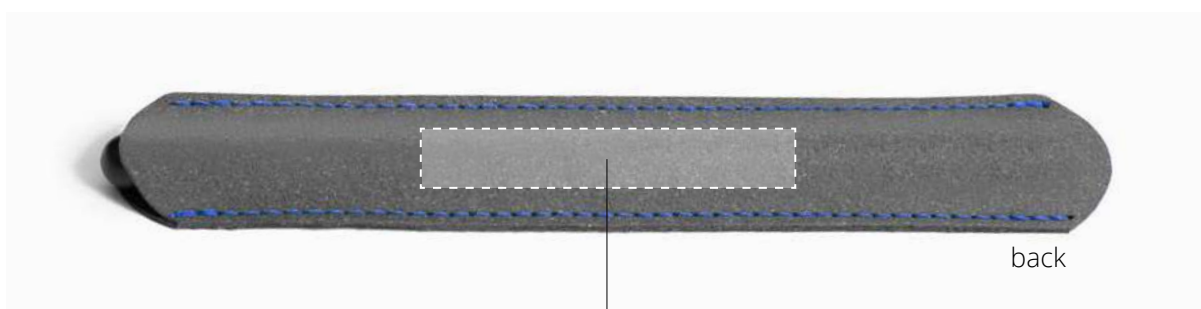

Incisione laser - Stampa UV (max 100x13 mm)
Laser engraving - UV printing (max 100x13 mm)

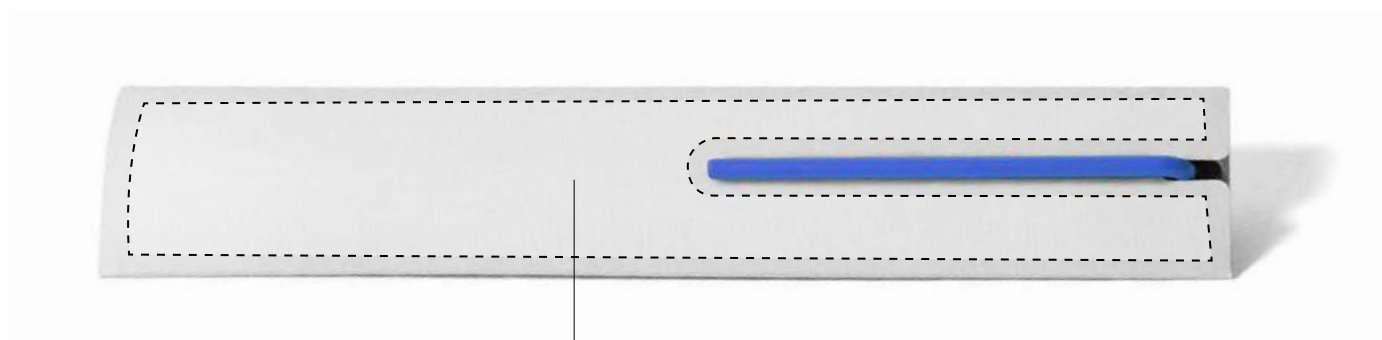

Possibilità di personalizzazione a partire da 1000pz
Possibility of customization from 1000pcs



SCHEDA TECNICA / TECHNICAL SHEET

| | |
|--|--|
| Materiale corpo <i>Body material</i> | Alluminio verniciato <i>Painted aluminium</i> |
| Puntale <i>Tip</i> | Punta a sfera <i>Ink ballpoint</i> |
| Dimensioni corpo <i>Body dimensions</i> | Lunghezza 152mm - Larghezza 12mm <i>Length 152mm - Width 12mm</i> |
| Peso corpo <i>Body weight</i> | 22gr <i>22gr</i> |



Disponibile su richiesta. Gli sleeve sono con le impunture nere per tutte le varianti colore.
Available upon request. Sleeves are with black stitching for all color variants.

Disponibile in 6 varianti
Available in 6 versions



Blu
Blue
GFX002BL

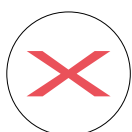

Rosso
Red
GFX002RO

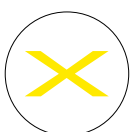

Giallo
Yellow
GFX002GI



Verde
Green
GFX002VE



Arancione
Orange
GFX002AR



Viola
Purple
GFX002VI

GRAFEEX

penna / ballpoint



Incisione laser - Stampa UV (max 110x5 mm)
Laser engraving - UV printing (max 110x5 mm)

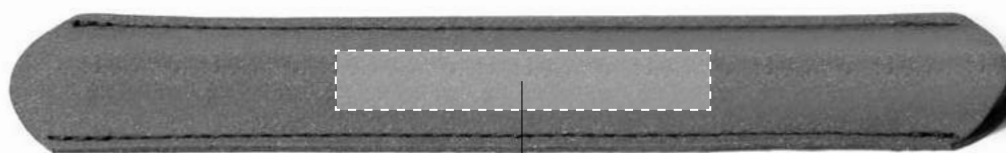

back

Incisione laser - Stampa UV (max 100x13 mm)
Laser engraving - UV printing (max 100x13 mm)

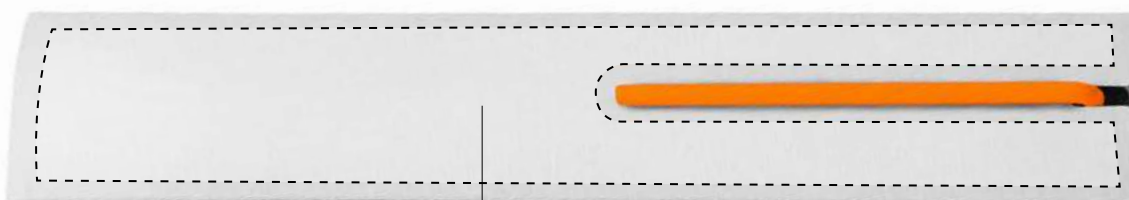

Possibilità di personalizzazione a partire da 1000pz
Possibility of customization from 1000pcs

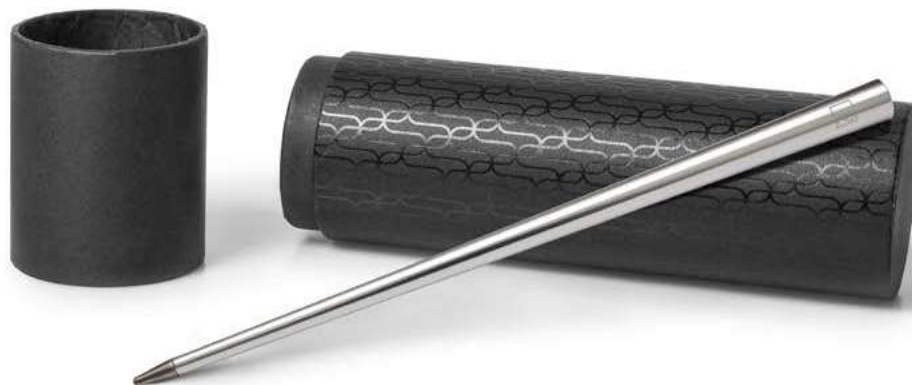

SCHEDA TECNICA / TECHNICAL SHEET

| | |
|--|--|
| Materiale corpo <i>Body material</i> | Alluminio 6060 <i>6060 Aluminium</i> |
| Puntale <i>Tip</i> | Lega di metalli Ethergraf® <i>Ethergraf® metal alloy</i> |
| Dimensioni corpo <i>Body dimensions</i> | Lunghezza 180mm - diametro 10mm <i>Lenght 180mm - diameter 10mm</i> |
| Peso corpo <i>Body weight</i> | 20gr <i>20gr</i> |

Disponibile in 9 varianti standard e 2 lusso
Available in 9 versions and 2 luxury



Titanio
Titanium
NPKRE01567



Argento
Silver
NPKRE01565



Oro
Gold
NPKRE01570

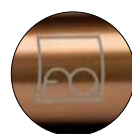

Rame
Copper
NPKRE01569



Ruggine
Rust
NPKRE01568

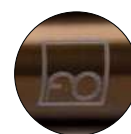

Bronzo
Bronze
NPKRE01566



Rosso
Red
NPKRE01509



Nero
Black
NPKRE01502



Blu
Blue
NPKRE01510



Placcata Oro
Gold Plated
NPKRE01591



Placcata Oro Rosa
Rose Gold Plated
NPKRE01653

PRIMA

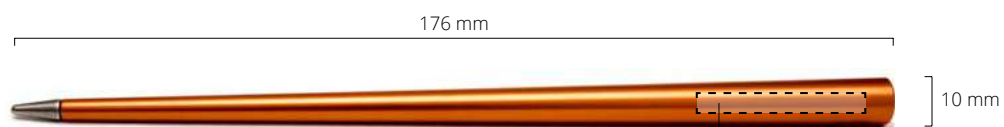

Incisione laser - Stampa UV
(max 40x5 mm)
*Laser engraving - UV printing
(max 40x5 mm)*



Adesivo tondo su tubo in cartone
Round sticker on cardboard tube



PRIMA GOLD EDITION



Adesivo tondo su tubo in cartone
Round sticker on cardboard tube



Incisione laser - Stampa UV
(max 40x5 mm)
*Laser engraving - UV printing
(max 40x5 mm)*

Varianti lusso *Luxury version*



Placcata Oro
Gold Plated
NPKRE01591



Placcata Oro Rosa
Rose Gold Plated
NPKRE01653



PRIMINA



SCHEDA TECNICA / TECHNICAL SHEET

| | |
|---|---|
| Materiale corpo <i>Body material</i> | Stelo in alluminio tornito e verniciato <i>Turned aluminium colour sprayed</i> |
| Puntale <i>Tip</i> | Lega di metalli Ethergraf® <i>Ethergraf® metal alloy</i> |
| Dimensioni corpo <i>Body dimensions</i> | Lunghezza 113mm - diametro 10mm <i>Length 113mm - diameter 10mm</i> |
| Peso corpo <i>Body weight</i> | 17gr <i>17gr</i> |

FINO AD ESAURIMENTO SCORTE

Disponibile in 9 colori
Available in 9 colors

AVAILABLE WHILE SUPPLIES LAST

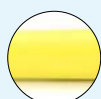

Giallo
Yellow
NPKRE01547



Arancione
Orange
NPKRE01548



Rosso
Red
NPKRE01549



Magenta
Magenta
NPKRE01550



Viola
Purple
NPKRE01551



Blu
Blue
NPKRE01552



Ciano
Cyan
NPKRE01553

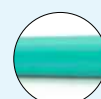

Turchese
Turquoise
NPKRE01554



Verde
Green
NPKRE01555

Black & White Edition

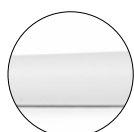

Bianco
White
NPKRE01556P

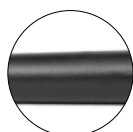

Nero
Black
NPKPE020

Silver Edition

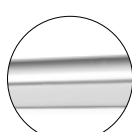

Argento
Silver
NPKRE01650

Primina I ♥ YOU Edition

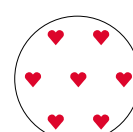

Bianco + Cuori
Hearts
NPKRE01589

PRIMINA



Stampa a colori UV su pack bianco - dettagli a parte
Color UV printing on white pack - details aside





CUBAN



SCHEDA TECNICA / TECHNICAL SHEET

| | |
|--|---|
| Materiale corpo <i>Body material</i> | Legno di acero, cedro o multistrato <i>Maple wood, cedar wood, plywood</i> |
| Puntale <i>Tip</i> | Lega di metalli Ethergraf® <i>Ethergraf® metal alloy</i> |
| Dimensioni corpo <i>Body dimensions</i> | Lunghezza 100mm - diametro 20mm <i>Length 100mm - diameter 20mm</i> |
| Peso corpo <i>Body weight</i> | 29gr <i>29gr</i> |

Disponibile in 3 varianti
Available in 3 versions



Acero
Tobacco
NPKRE01520



Cedro
Cedar
NPKRE01537



Multistrato
Multilayer
NPKRE01521

CUBAN

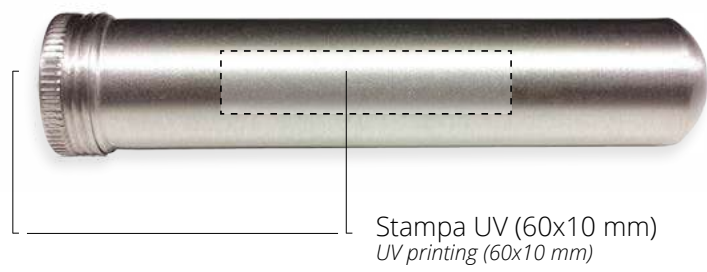
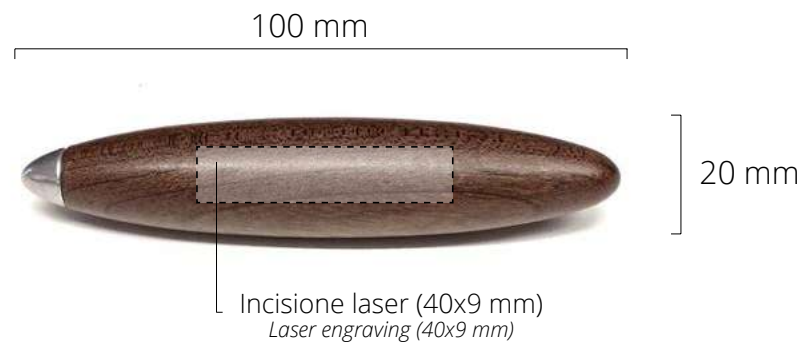



SCHEDA TECNICA / TECHNICAL SHEET

| | |
|---|---|
| Materiale corpo <i>Body material</i> | Stelo in alluminio pressofuso con inserti in gomma siliconica <i>Diecast aluminium with siliconic rubber inserts</i> |
| Puntale <i>Tip</i> | Lega di metalli Ethergraf® <i>Ethergraf® metal alloy</i> |
| Dimensioni corpo <i>Body dimensions</i> | Lunghezza 152mm - diametro 10mm <i>Length 152mm - diameter 10mm</i> |
| Peso corpo <i>Body weight</i> | 40gr <i>40gr</i> |



Disponibile in 2 varianti
Available in 2 versions



Nero
Black
NPKRE01652



Canna di fucile
Gun Metal
NPKRE01767





SCHEDA TECNICA / TECHNICAL SHEET

| | |
|---|--|
| Materiale corpo <i>Body material</i> | Corpo in legno con anella in argento <i>Body in wood, with a silver ring</i> |
| Puntale <i>Tip</i> | Mina in grafite diam. 2mm <i>Graphite lead (diam. 2mm)</i> |
| Dimensioni corpo <i>Body dimensions</i> | Lunghezza 150mm - diametro 6mm - 11mm <i>Length 150mm - diameter 6mm - 11mm</i> |
| Peso corpo <i>Body weight</i> | 6-8gr <i>6-8gr</i> |

Disponibile in 1 variante
Available in 1 version

Edizione speciale
Special Edition



Cigliegio
Cherry wood
STZ001CI



Amaranto
Amaranth
STZ001AM

SOSTANZA



Incisione laser (35x0,4 mm)
Laser engraving 35x0,4 mm



Incisione laser (35x0,4 mm)
Laser engraving 35x0,4 mm

Processo di personalizzazione

Il processo di personalizzazione prevede l'incisione del logo cliente sul prodotto e può avvenire con diverse tecnologie, a seconda dei materiali.

Customization process

Customization process includes customer's logo engraving on the product and can be achieved through different technologies due to materials.

Per le dediche o i nomi propri sono disponibili i seguenti caratteri:

For dedications or single names the following typeface are available:

1. Allura

*ABCDEFGHIJKLMNOPQRSTUVWXYZ
abcdefghijklmnopqrstuvwxyz
0123456789*

2. England

*ABCDEFGHIJKLMNOPQRSTUVWXYZ
abcdefghijklmnopqrstuvwxyz
0123456789*

3. Garamond

ABCDEFGHIJKLMNOPQRSTUVWXYZ
abcdefghijklmnopqrstuvwxyz
0123456789

4. Copperplate

**ABCDEFGHIJKLMNOPQRSTUVWXYZ
ABCDEFGHIJKLMNOPQRSTUVWXYZ
0123456789**

5. Dosis

ABCDEFGHIJKLMNOPQRSTUVWXYZ
abcdefghijklmnopqrstuvwxyz
0123456789

6. Open Sans

ABCDEFGHIJKLMNOPQRSTUVWXYZ
abcdefghijklmnopqrstuvwxyz
0123456789



Signature S.r.l.

Via P. Frisi, 70 - 48124 Ravenna - ITALY

T. +39 0544 590510

P.IVA 02595930393

pininfarinasegno.it

REV. 1.7 - 15422